



Parachutes Australia



Slimpack Parachute Manual

S/N: _____

DATE OF MANUFACTURE: _____

Manufactured by:



Parachutes Australia

22 Bosci Rd, Ingleburn NSW Australia 2565
Ph +61 2 9829 5355 Fx +61 2 98291300
Email: sales@parachutesaustralia.com

TABLE OF CONTENTS

| | |
|---|-----------|
| TABLE OF CONTENTS..... | I |
| WARNING !!!..... | 1 |
| WARRANTY..... | 2 |
| 1.0 SLIMPACK TEST STANDARD..... | 3 |
| 2.0 SLIMPACK CONFIGURATIONS..... | 4 |
| 3.0 FITTING & ADJUSTMENT..... | 6 |
| 4.0 OPERATING INSTRUCTIONS..... | 7 |
| 4.0 RIPCORD OPERATION (ALL MODELS)..... | 7 |
| 4.2 STATIC LINE OPERATION (MODEL T104)..... | 8 |
| 4.3 UNDER CANOPY..... | 9 |
| 4.4 STEERING THE PARACHUTE..... | 10 |
| 4.5 LANDING PROCEDURE (GENERAL)..... | 11 |
| 4.6 EMERGENCY LANDINGS..... | 12 |
| 5.0 OPERATING LIMITATIONS..... | 13 |
| 6.0 MAINTENANCE..... | 14 |
| 6.1 DAILY MAINTENANCE..... | 14 |
| 6.2 MINOR REPAIR..... | 14 |
| 6.3 MAJOR REPAIR..... | 14 |
| 6.4 AN ALTERATION..... | 14 |
| 6.5 REPAIR METHODS..... | 14 |
| 6.6 MODIFICATON (RECALL)..... | 15 |
| 6.7 SERVICE LIFE..... | 15 |
| 6.8 STORAGE..... | 15 |
| 7.0 INSPECTION AND PACKING..... | 16 |

| | |
|--|-----------|
| 7.1 AIRING AND DRYING (ALL MODELS)..... | 16 |
| 7.2 INSPECTION (ALL MODELS)..... | 16 |
| 8.0 CLOSING LOOP INSTALLATION (ALL MODELS)..... | 17 |
| 8.1 CLOSING LOOP INSTALLATION MODEL – T201 & T202..... | 17 |
| 8.2 CLOSING LOOP/STATIC LINE INSTALLATION - MODEL T204..... | 17 |
| 9.0 PACKING SEQUENCE – MODEL T202 & T204..... | 18 |
| 10.0 PACKING SEQUENCE – MODEL T201..... | 21 |
| 11.0 CLOSING THE CONTAINER (ALL MODELS)..... | 23 |
| 12.0 CONTINUING PRODUCT SUPPORT..... | 26 |
| 13.0 REPLACEMENT PARTS AND MATERIALS..... | 27 |
| 14.0 MODIFICATION (RECALL) ORDERS..... | 31 |
| 15.0 RECORD OF REPAIRS AND ALTERATIONS..... | 32 |

WARNING !!!

RISKS OF GLIDING

- Gliding has caused death and serious injuries.
- Emergency parachutes do not always open properly, due to pilot error.
- Emergency equipment can fail even if all possible precautions are taken by the pilot.
- Failure to activate the main or reserve parachute (or execute emergency procedures) at a safe altitude, and/or equipment failure can result in serious injury or death.

PILOT RESPONSIBILITIES

- Read and strictly follow all operating instructions and all manufacturer's specifications, instructions, advice and requirements for use of the equipment.
- Never attempt to use equipment prepared or assembled by unqualified persons.
- Use only manufacturer recommended compatible components.
- Examine and replace any defective, worn or deteriorated component of the equipment.
- Examine all gear and equipment, including all fittings, buckles, snaps and other fasteners before use of any parachute product.
- Use only those products designed for parachute use.
- Do not exceed recommended or stated forces, speeds or other factors regarding safe use of equipment.
- Read and follow all warning labels, manuals, instructions, training or other experience requirements and recommendations and all recognised parachute procedures.
- Check the ripcord handle and pins for security (and static line hook up if applicable) before each launch.
- Comply with all product recall notices, mandatory modifications and/or Rigging Advisory Circulars (RACs) relating to the equipment.

**FAILURE TO FOLLOW ALL WARNINGS, INSTRUCTIONS AND REQUIRED
PROCEDURES MAY RESULT IN SERIOUS INJURY OR DEATH**

WARRANTY

PARACHUTES AUSTRALIA expressly warrants that these goods will be free from defects arising from faulty material and workmanship. The liability of Parachutes Australia is limited to the replacement of defective parts found upon examination to be defective in material or workmanship within 21 days of purchase. This warranty does not apply to goods that have:

- a. Not been used in accordance with the express or implied instructions and specifications of Parachutes Australia;
- b. Altered or repaired in any way;
- c. Been subjected to abuse, misuse, abnormal stress or strain, or neglect of any kind;
- d. Become directly or indirectly defective from wear and tear;
- e. Been used after the discovery of any defect or deficiency that has not been rectified by Parachutes Australia after the purchaser has notice of such defect or deficiency.

Parachutes Australia will not accept goods returned without prior arrangement.

1.0 SLIMPACK TEST STANDARD

The Slimpack Parachute Assembly has been tested to the requirements of Department of Aviation, Air Navigation Order ANO 103.18 Equipment Standards – Emergency Parachutes.

To demonstrate compliance with ANO 103.18, the United States Federal Aviation Administration, Technical Standard Order T.S.O – C23b was used as the specification.

Parachutes Australia holds both Certificates of Type Approval (CTA) issued by the Australian Civil Aviation Safety Authority (CASA) and letters of TSO Authorisation from the United States FAA for the various component parts that make up the Slimpack Parachute Assembly.

The Slimpack Parachute Assembly will meet the requirements for a ‘Standard’ category parachute provided the canopy fitted to the Slimpack pack and harness has been certified to the standard type category.

Where a ‘Low speed type’ category parachute canopy is fitted to the Slimpack pack and harness assembly, the resulting assembly must be identified as a Low Speed Parachute and is limited to use in airplanes under 150mph.

2.0

SLIMPACK CONFIGURATIONS

2.1 The Slimpack parachute, as of 1 July 1988, is available in three configurations which are identified by a single part number. The single part number will include all the component parts assembled and packed ready for use. These are:

2.2 **T201 SLIMBACK PARACHUTE** assembly, a low speed category, civil use parachute, consisting of the following primary parts:

| | |
|-----------|--|
| S003-HS-1 | Pack and harness assembly |
| H006-1 | Ripcord |
| P015-1 | Canopy, Aerolite |
| B021-A | Pilot Chute, Slimpack/Thinback |
| B021(S) | Strap, Pilot Chute B021 |
| B019 | Bridle cord, 1 metre |
| B069 | Closing loop, Slimpack S005(A), S005-A-2, S005-A-3 |
| A023 | Manual, Slimpack parachute |

2.3 **T202 SLIMPACK PARACHUTE** assembly, standard category, civil use, consisting of the following primary parts:

| | |
|-----------|--------------------------------|
| S003-HS-1 | Pack and harness assembly |
| H006-1 | Ripcord |
| P008A | Canopy, 26' Lopo, modified |
| B021-A | Pilot Chute, Slimpack/Thinback |
| B021(S) | Strap, Pilot Chute B021 |
| B019 | Bridle cord, 1 metre |
| B069 | Closing loop |
| A023 | Manual, Slimpack Parachute |

2.4 **T204 SLIMPACK PARACHUTE**, assembly static line/rip cord deployed, standard category, civil use, consisting of the following primary parts:

| | |
|--------|-------------------------------------|
| S003-G | Pack and harness assembly |
| H006-1 | Ripcord |
| P008A | Canopy, 26' Lopo, modified |
| B021-A | Pilot Chute, Slimpack/Slimpack |
| B019 | Bridle cord, 1 metre |
| B074 | Static line |
| B077 | Closing loop, model S005-G & S003-G |
| A023 | Manual, Slimpack Parachute |

- 2.5** Slimpack parachute parts may be purchased separately, alternative parts may be substituted provided they meet the following criteria: (Extract from FAA Advisory Circular AC 105.2A)

“Assembly or mating of parachute components from different manufacturers may be made by a certified and appropriately rated parachute rigger or parachute loft without further authorisation by the manufacturer. Each component of the resulting assembly should function properly and may not interfere with the operation of the other components. Any questions about the strength or operation should be resolved by actual tests by the rigger or loft to make certain the parachute is safe for emergency use.”

- 2.6** Prior to 1 July 1988, the Slimpack pack and harness assembly was available in two models.

The ‘STANDARD CATEGORY’ Slimpack parachute assembly, part number S3 (SC) was supplied with the P008A canopy, B021 pilot chute, B019 bridle cord and H006 ripcord.

The ‘LOW SPEED CATEGORY’ Slimpack parachute assembly, part number S3 (LS) was supplied with the P007 24’ ripstop canopy, B021 chute, B019 bridle cord and H006 ripcord.

- 2.7** Packing, inspection and operation of the S3 (SC) and S3 (LS) should be carried out in accordance with the Slimpack II Manual, PA stock number A023, Rev B, dated 20.07.87 or alternatively in accordance with this manual.

- 2.8** Parachute packers and riggers are advised to take note of any modification (recall) orders raised and issued for the Slimpack parachute or any component parts.

Refer to section 14.0 of this manual for modification orders applicable to the Slimpack parachute.

3.0 FITTING & ADJUSTMENT

The Slimpack Parachute Assembly is designed to be worn over coveralls or other form fitting clothing.

NOTE: Excessively loose clothing will make it difficult to observe the harness fittings when donning and may obscure the ripcord handle during use.

The harness is adjustable in five places:

- i) The chest strap
- ii) The left leg strap adjustable 'V' ring
- iii) The right leg strap adjustable 'V' ring
- iv) The left shoulder adjustable adapter
- v) The right shoulder adjustable adapter

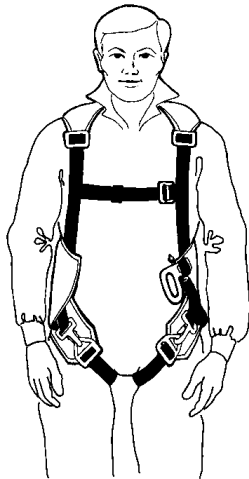

- The chest strap should be positioned at mid-chest level.
- The leg straps pass around each thigh and the adjustable 'V' ring connects to the snap on the front strap. Each leg strap should be adjusted up until snug, but not uncomfortably tight.
- The two shoulder adjustable adapters vary the length of the front harness. These are only used for wide variations in the length of the trunk which cannot be taken up with adjustments to the leg strap length.

4.0 OPERATING INSTRUCTIONS

4.0 RIPCORD OPERATION (ALL MODELS)

The Slimpack Parachute Assembly is manually activated.

The ripcord handle is to be firmly gripped with the right hand, removed from the pocket and pulled to full arms length, across the body.

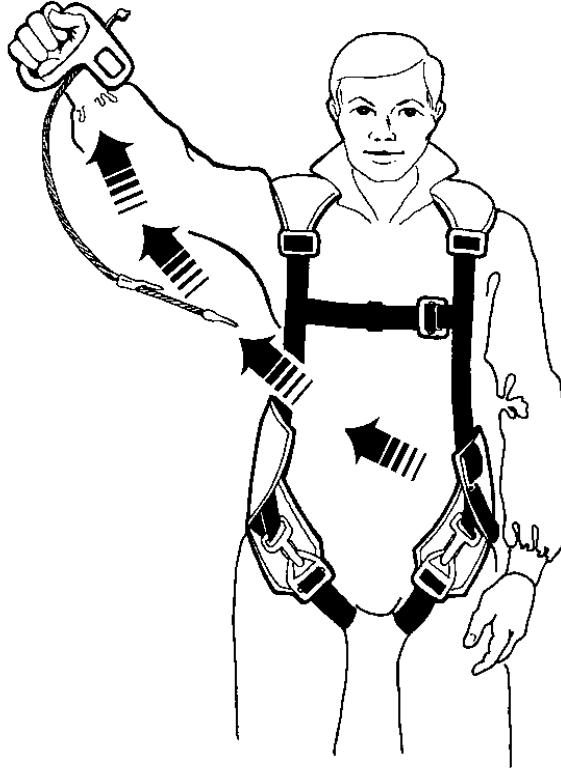

The parachute will normally open fully within 3 seconds of activation.

If an emergency arises which requires a quick exit from the aircraft, carry out the following steps:

- i) Check altitude above ground level.
- ii) If low (below 3000ft AGL) clear the aircraft and pull ripcord immediately.
- iii) If high (above 3000ft AGL & below 10,000ft AGL) clear aircraft, delay ripcord pull for 5 seconds.
- iv) If very high (above 10,000ft AGL) do not pull immediately but delay until altitude is lower.

Remember the outside air temperature may well be below freezing point. If you observe the ground rush up, pull ripcord immediately.

4.2 STATIC LINE OPERATION (MODEL T104)

- The T204 Slimpack Parachute may be ripcord or static line deployed.
- If the parachute is to be static line deployed the static line carabina snap must be connected to a strongpoint inside the aircraft.
- The static line is 6 meters long and is stored under a velcro closed flap on the top outside of the Slimpack.
- The static line strongpoint should be located behind or beside the seat position. It is important that a clear path is maintained between the static line anchor point and the stowage pouch as the user leaves the aircraft during a flight emergency.
- If the static line is to be used regularly the carabina snap should be stowed on the left shoulder.
- If it is not used regularly it is suggested that the carabina and all the static line webbing be stowed in the pouch at the back.

Refer to section 8.0 for recommended stowage method.

4.3 UNDER CANOPY

Once suspended under the parachute canopy, your rate of descent will stabilise at approximately 17.9 ft/sec with a 77kg (170lb) body weight.

This rate of descent is based on the Parachutes Australia 26' Lopo Conical Canopy (part P008A) or the Aerolite Canopy (Part No P015-1) being fitted into the Slimpack pack and harness assembly.

Parachute canopies from other manufacturers may have a different rate of descent.

Your parachute will look circular in shape and, being 'modified' for steering, it will have three vents facing towards the rear, which give a 3 to 10kt airspeed (depending upon body weight and altitude) in the direction you are facing.

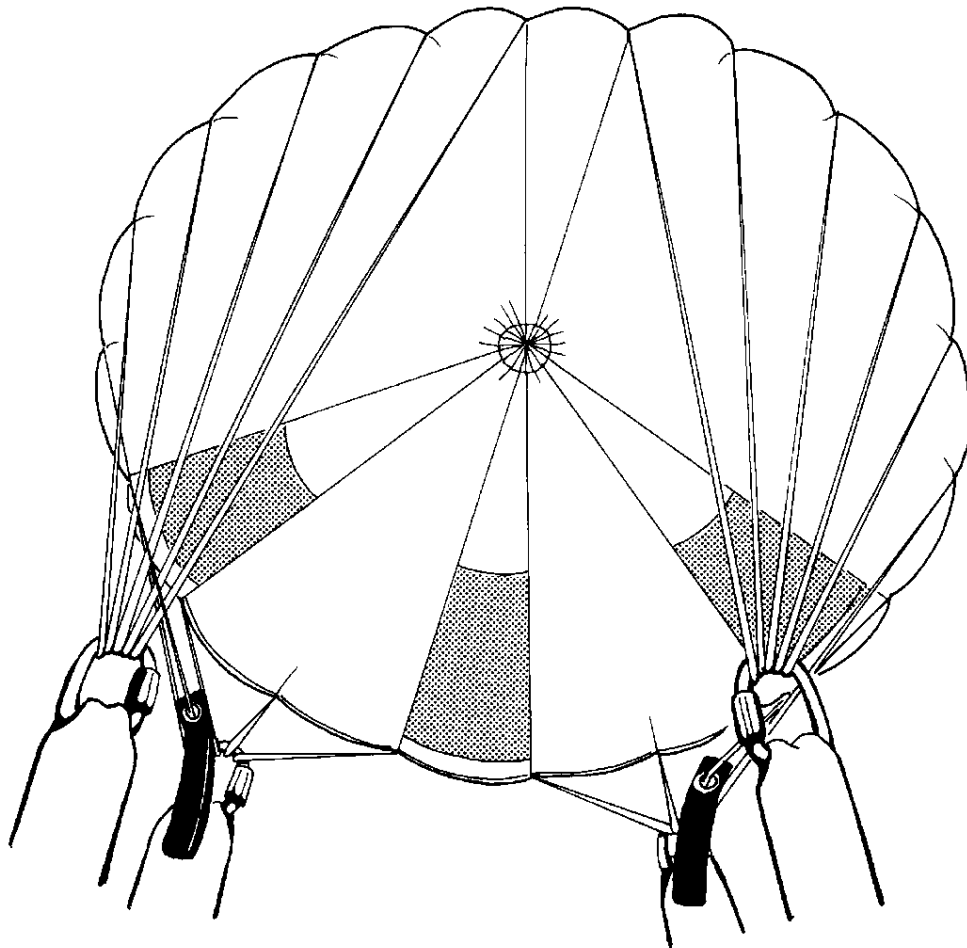

4.4 STEERING THE PARACHUTE

- The parachute can be turned to the left or right or completely around, by operating the left or right steering toggles, or the rear risers if toggles are not fitted.
- The parachute will fly straight ahead if neither steering toggles is touched.
- To turn the parachute to the left (port) the left side steering line must be grasped and pulled down to chest level.
- The parachute will continue to turn until the steering line is released. The parachute

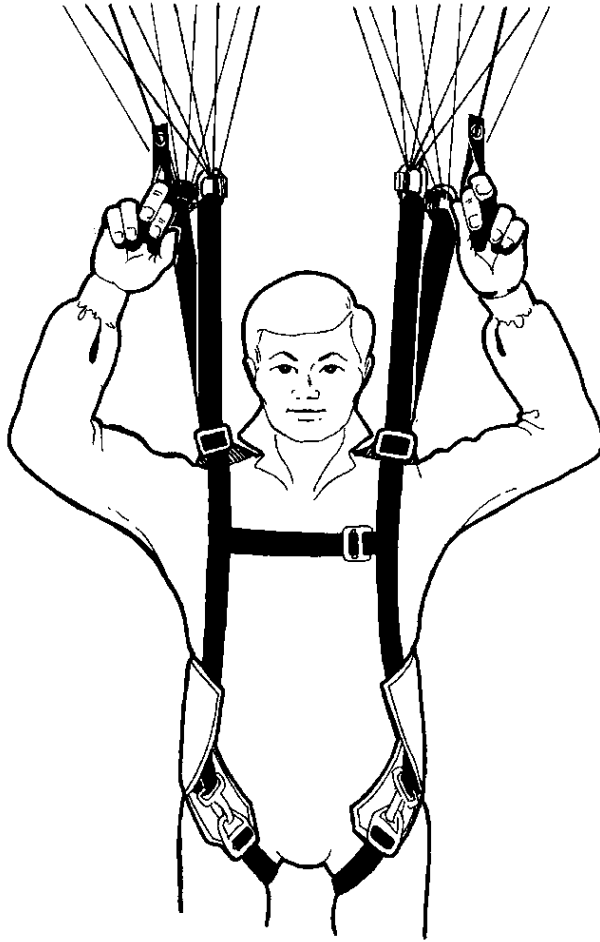

will stabilise in 3 to seconds and then assume a 3 to 10kt airspeed in the new direction. It takes 10 seconds to complete a 360° turn.

- As with aircraft flight, the wind speed and direction will influence your 'track' across the ground.
- Choose a heading to achieve a track across the ground towards the best landing area available (downwind).
- As a guide, your glide angle is approximately 45° to the horizontal in light winds.

4.5 LANDING PROCEDURE (GENERAL)

- The parachute should be maneuvered so that you are facing into wind for landing.
- As with other forms of flight, this minimises your speed over the ground at the time of landing.
- The normal procedure for assessing ground wind such as smoke, cloud shadows, ripples on water and grass should be used.
- Use either left or right steering toggles to turn the parachute so you are facing 'into wind' and prepare for the landing.
- Lock your legs together from thighs to ankles. Bend knees slightly forward and brace yourself as if you were to jump off a 2 metre high platform.

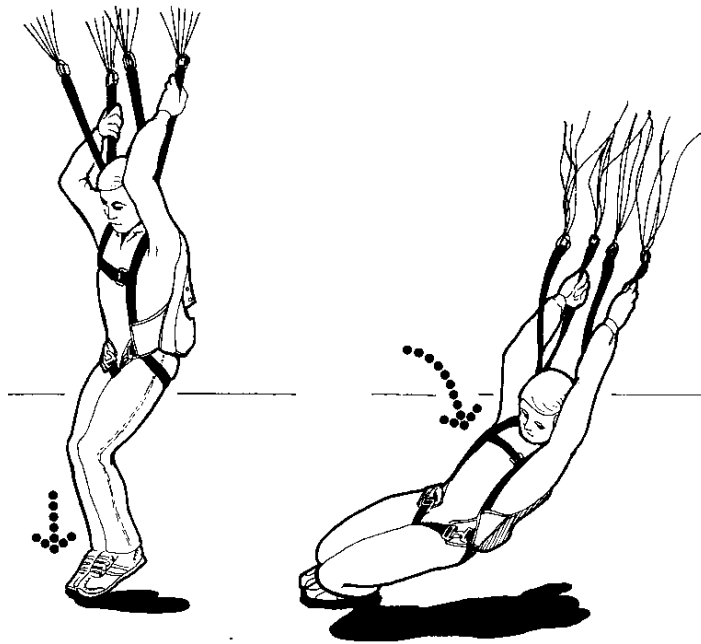

- Roll your body along your side to absorb landing shock.

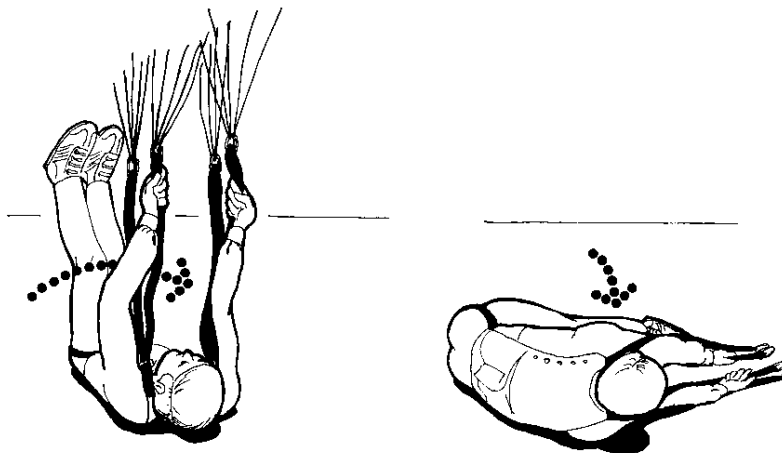

4.6 EMERGENCY LANDINGS

4.6.1 WATER LANDING

- Turn the parachute to face ‘into wind’ to land as you would for a normal landing. *Facing into wind is absolutely necessary for all water landings.*
- Release the chest strap as you descend under the parachute. This will save time in the water.
- If you land in water facing ‘into wind’, you may be towed across the water on your back (face up) if wind strength is high.
- If you land facing ‘down wind’, you will enter the water face down and may be dragged under.
- After landing in the water, release both leg strap snaps. Discard the parachute and swim away.
- Always head up wind and up current away from the parachute to avoid entanglement.
- Once water logged, the parachute will sink!

4.6.2 POWER LINE LANDING

- Steer away from power lines by turning the parachute to face away from them.
- If unable to avoid power lines, place feet together, turn head to the side and try not to touch more than one line.
- If suspended above the ground, make sure power has been disconnected before a rescue attempt is made.

4.6.3 TREE LANDING

- Always steer the parachute to avoid trees.
- If a tree landing is unavoidable, place feet and knees together, tuck elbows into stomach, protect your face with your hands. Place chin on chest.

4.6.4 DRAGGING AFTER LANDING

- The parachute may remain inflated after landing, if winds are greater than 10kts.
- If being dragged across the grounds by high winds, roll onto your back. The backpack will provide some protection from abrasion.
- Reach up and grasp one of the lower rigging lines of the parachute and pull down hand over hand until the canopy is distorted enough to collapse.

5.0 OPERATING LIMITATIONS

| | |
|------------------------------------|---|
| Minimum deployment height: | 500ft AGL |
| Recommended Weight range: | 50kg (110lb) to 100kg (220lb) |
| Stability: | $\pm 5^{\circ}$ from vertical at gross wt. |
| Height loss during opening: | 300ft |
| Ripcord pull force: | 23 N (5lbf) min. 97 N (22lbf) max. |
| Forward drive: | 3-10 knots (depending upon weight) |
| Steerability: | 360 ^o in 10 secs at gross weight |
| Opening time: | 3 secs (normal opening) |

6.0 MAINTENANCE

The responsibility for maintenance and repair of the Slimpack Parachute lies with appropriately qualified parachute rigger or packer.

Any suspected damage from acid, oil, water, chaffing, cuts, burred fittings, wear, sunlight, etc., should be referred to an approved maintenance workshop.

Repairs may only be classified as repairs when they restore the parachute to its original condition. Repairs are classified as daily maintenance, minor repair or major repair.

6.1 DAILY MAINTENANCE

Shall mean the replacement of component parts which require assembly only. Daily maintenance is within the scope of a parachute packer (Australian Parachute Federation “A” Packer, or the foreign equivalent).

6.2 MINOR REPAIR

A repair other than a major repair is classified as a minor repair. For example, a ripcord pocket repair, hand tacking, stain removal, canopy patch. All minor repairs are within the scope of a parachute rigger (Australian Parachute Federation Class “B” Rigger, or the foreign equivalent).

6.3 MAJOR REPAIR

A repair, if improperly accomplished, might appreciably affect strength, performance, flight characteristics or any other factor effecting airworthiness. A major repair is within the scope of a parachute rigger (Australian Parachute Federation Class “B” Rigger, or the foreign equivalent).

6.4 AN ALTERATION

Is any change in the configuration of any portion of a parachute assembly from its original manufacturer specifications.

Any alteration must only be carried out by the manufacturer or with his written approval.

6.5 REPAIR METHODS

The only approved method of repair is the re-manufacture of complete factory-like replacement of the damaged area. In making the repair, the parachute itself should be

used as the model. All parts, seams and methods should exactly duplicate the original. For repair techniques, refer to “The Parachute Manual”, author Dan Poynter, ISBN 0-915516-35-7, particularly Section 7.0.

6.6 MODIFICATION (RECALL)

A modification order shall be raised and issued to the owner/operator of the parachute whenever:

A superior part or material becomes available which will improve the parachute’s performance and/or reliability, or

A defect becomes evident which requires the parachute to be recalled and modified.

Modification orders shall be numbered and be classified as mandatory or optional.

6.7 SERVICE LIFE

The Slimpack Parachute assembly has a maximum service life of 20 years from the date of manufacture stamped on the parachute back (whether used or in storage), due to the natural degradation of the nylon used for its manufacture. The parachute canopy fitted to the Slimpack Parachute pack and harness assembly may have service life which differs from the pack and harness. Time expired components must be removed and replaced with serviceable components in order for the complete parachute to remain in service.

Some countries have a finite life on all parachutes which is less than that specified by the manufacturer. Where this is the case the country’s regulations shall prevail.

6.8 STORAGE

The Slimpack Parachute must be stored in dry shaded conditions, away from excessively high temperature and humidity when not in use.

7.0 INSPECTION AND PACKING

The Slimpack Parachute must be maintained, packed and operated in accordance with this manual or in accordance with an approved manual which contains these maintenance and packing procedures.

Parachutes Australia, as the manufacturer, authorises the Slimpack Parachute to remain in service for a maximum period of 8 months between each mandatory inspection and repack.

However, where the statutory regulations of the country of use require a lesser in-service period than the 8 months authorised by the manufacturer, the lesser period shall apply.

NOTE: Australian Air Navigation Orders require an emergency or reserve parachute to have been inspected and repacked in the preceding 6 months.

A Slimpack parachute which has been damaged or found unserviceable, must not be worn unless it has been repaired and certified as serviceable by a current Australian Parachute Federation Class “B” Rigger, or a holder of the foreign equivalent rating.

7.1 AIRING AND DRYING (ALL MODELS)

Prior to being repacked, the Slimpack Parachute canopy must be hung by the apex for a period of 24 hours, out of direct sunlight, without the canopy coming in contact with the floor. Lines should be loosely chain linked and placed in the pack tray.

7.2 INSPECTION (ALL MODELS)

Prior to packing, the Slimpack Parachute must be inspected.

- Stretch the canopy, rigging lines and harness out on the packing table.
- Remove any tangles from the canopy, rigging lines and harness.
- Attach the canopy apex to one end of the table.
- Attach the ‘rapide’ connector links to the tensioning device at the other end and apply 30 kg (approx.) tension.
- Examine the complete parachute assembly for holes, tears, sears, broken and loose stitching, wear and contamination by oil and acid.
- Examine metal harness fittings for burrs, nicks, broken springs and rust.
- Check ‘rapide’ connector links are correctly tensioned. They should be tightened by hand, then tensioned ¼ turn with a spanner.

8.0 CLOSING LOOP INSTALLATION (ALL MODELS)

8.1 CLOSING LOOP INSTALLATION MODEL – T201 & T202

Take two closing loop assemblies (as shown in the figure below) and mount them through the container floor as shown on page 19.

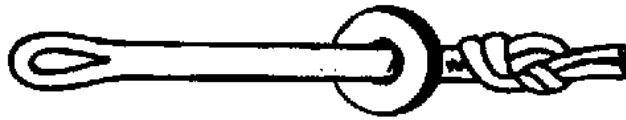

8.2 CLOSING LOOP/STATIC LINE INSTALLATION - MODEL T204

A static line (part number B074), two closing loops (part number B077) and a ripcord (part number H006-1) are required for the static line Slimpack.

- Smear a very thin film of clear non-staining sewing machine oil over both cables with a lightly oiled rag. This procedure is necessary to maintain a static line pull force of less than 97 N (22 lbf).
- Ensure the oil does not come in contact with the parachute canopy.
- Feed two static line cables through the grommet located behind the 50mm wide velcro pile pocket in the static line stowage pouch.
- Fold the velcro hook over the outside of the velcro pile pocket to secure the cable in place.
- Take two closing loops and pass one over the end of each cable.
- Slide the loops along each cable. The loop on the shorter cable must pass through the grommet closest to the top of the container.
- After passing the loop on the longer cable through the lower grommet, the excess cable must be stowed in the webbing tube pocket on the inside bottom of the container tray.
- Use the three (3) rubber bands on each side of the stowage pouch to secure the static line in place.
- The first three (3) metres of static line should be stowed in the lower two bands.
- The next two (2) metres should be stowed in the middle bands.
- The last metre should be stowed in the upper rubber bands.
- If the Slimpack parachute is to be regularly static line activated, the carabina should be stowed in the keeper over the left shoulder.
- If not, the carabina is to be stowed inside the static line pouch.

9.0 PACKING SEQUENCE – MODEL T202 & T204

The T202 & T204 Slimpack Parachute use the P008A 26' Lopo conical canopy.

- The master panel (No. 1) of the canopy should be facing up.
- Complete a 4-line check with lines number 1 & 24 and 12 & 13.
- Flake the canopy in the manner you are accustomed to.
- Lay the canopy down and pleat each gore ensuring 1 to 12 lay one side and 13 to 24 lay the other side.
- Visually check up the centre of the canopy to confirm that all gores are clear.
- Straighten the apex. The periphery should now align with $\pm 25\text{mm}$.

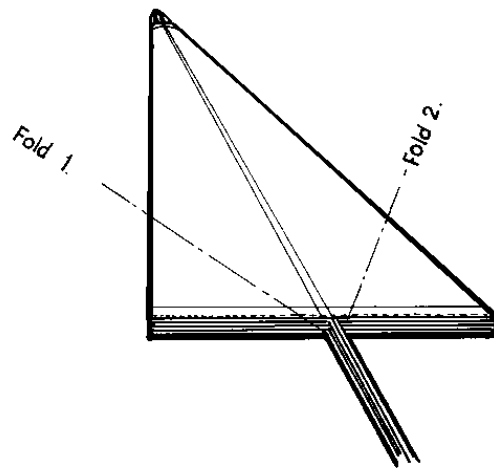

- Fold (triangulate) the periphery of the canopy along fold line 1 & 2, as shown above.
- The canopy should now resemble Fig. below:

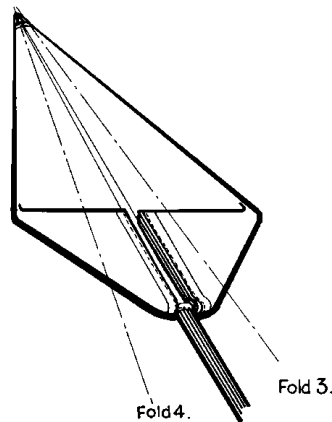

- Fold (longitudinally) the canopy into one third its width along fold line 3 & 4 on Fig. (see previous page).
- The canopy should now resemble Fig below:

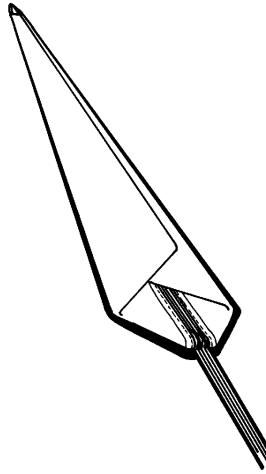

Use two or three shot bags to hold the canopy in place.

- Lay the risers down either side of the pack tray as shown in Fig. Below.
- Allow a 200mm length of the front lift web between the chest strap and the shoulder adjustable adapters to suit the average man.

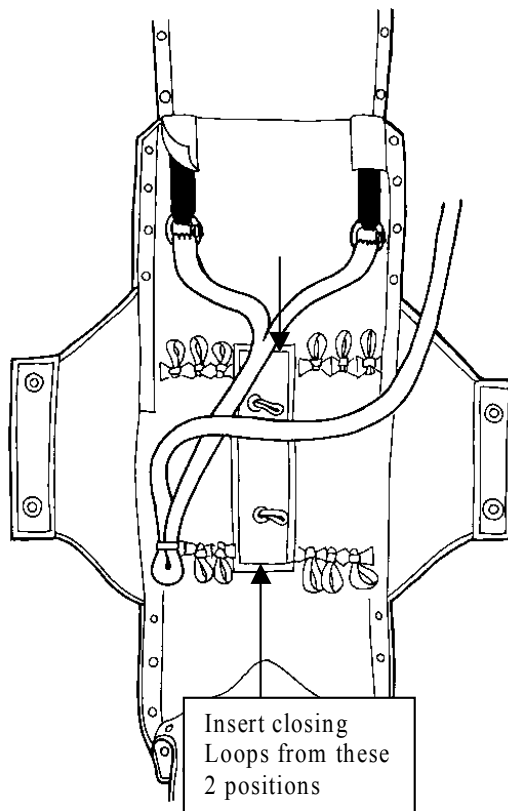

- Also, leave some line slack between the rapide connector links and the first line stow to allow some front lift web adjustment for individuals who are taller than average.
- Continue line stowage as illustrated in Fig. below until the periphery is within 300mm.

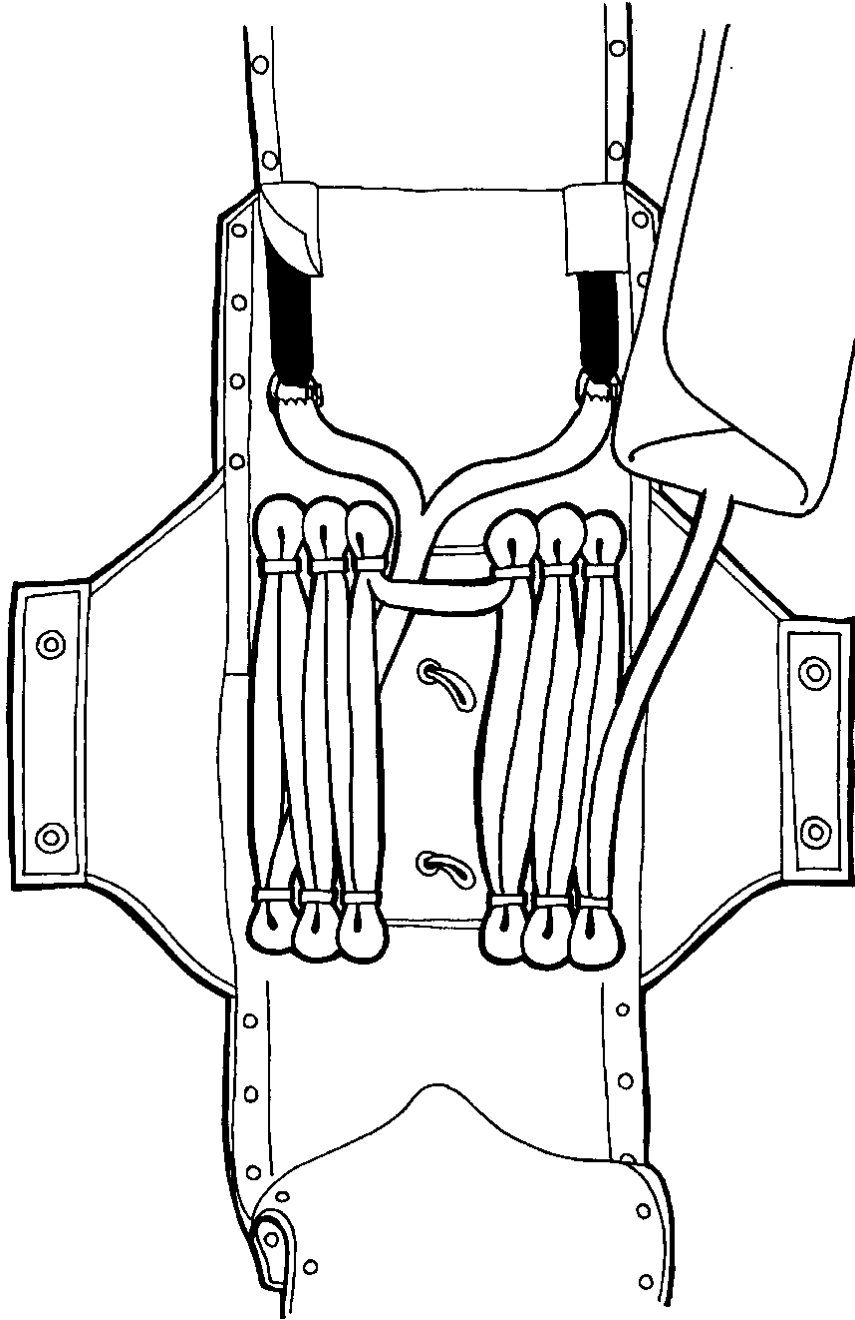

10.0 PACKING SEQUENCE – MODEL T201

The T201 Slimpack Parachute uses the Aerolite model P015-1 canopy.

- Flake the canopy in the manner you are accustomed to.
- Lay the canopy down and pleat each gore, ensuring equal numbers (10) lay on each side.
- Visually check up the centre of the canopy to confirm that it is clear.

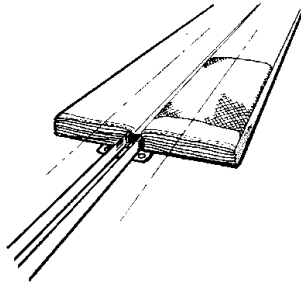

- Straighten the apex. All rigging lines at the periphery should align within ± 25 mm.
- Next fold the canopy into thirds bringing each side across as shown in Fig. below:

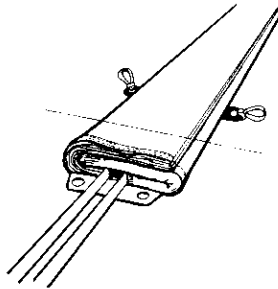

- Fold the periphery over so that the grommets are level with the *Nitrile Rubber ‘O’ Rings on the mouth lock. See Fig. below:

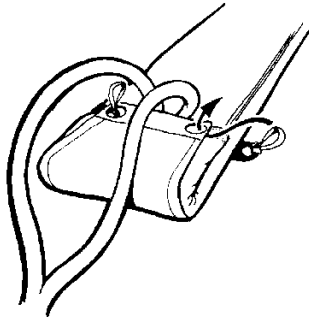

* PA Part Number M138-2 Nitrile Rubber ‘O’ Ring or commercial equivalent must be used for the mouth lock. Regular bands can be used elsewhere.

- Stow the left and right line groups separately in the respective * Nitrile Rubber ‘O’ Ring as illustrated in Fig. below:

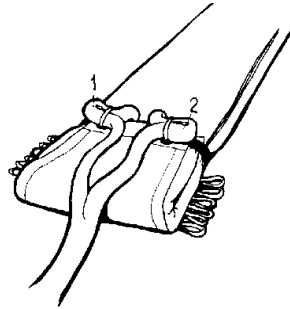

- Use regular rubber bands to stow the left and right line groups together as shown in Fig. below:

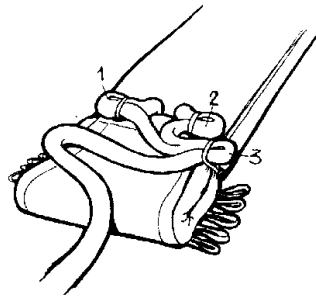

- Continue to the remaining lines as shown in Fig. below:

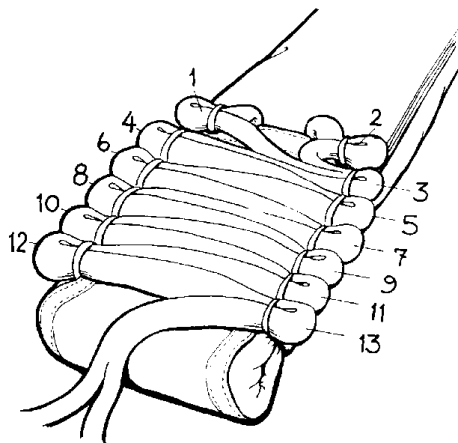

11.0 CLOSING THE CONTAINER (ALL MODELS)

- The periphery (skirt) of the canopy is stowed in the upper right hand corner of the pack, as illustrated in Fig. below.

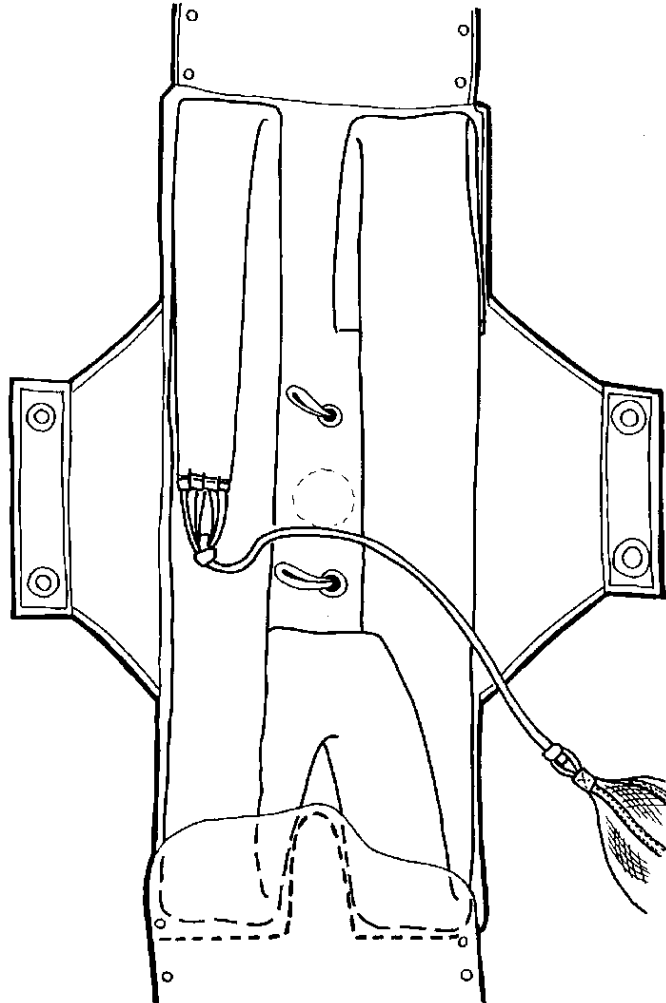

- Fold the canopy back on top of itself and continue down to the bottom right corner, thence to the centre. Fold level with bottom stowed live loops and back down to the left bottom corner.
- Fold the canopy back on itself then up the left side to the top left corner and finally back down the left side until the apex is stowed. It is important that the apex finished level with the pilot chute location disc.

- Clear the canopy material to either side of the raised disc for the pilot chute base location. Clear fabric away from the closing loops.
- Insert a pull-up cord of gutted MIL-C-5040 type III to each closing loop as illustrated above.
- To close the pack, the top flap is fastened down with press studs. The canopy fabric is then arranged to give a relatively square shape to the corners.
- The pull-up cords are passed through the grommets in the top and bottom flaps.
-
- Centre the pilot chute base on the circular raised disc on the stiffener plate between the two closing loops and compress the spring.
- Pass the pull-up cords through the grommets on the pilot chute location strap and use 2 temporary pins to retain the pilot chute in place.

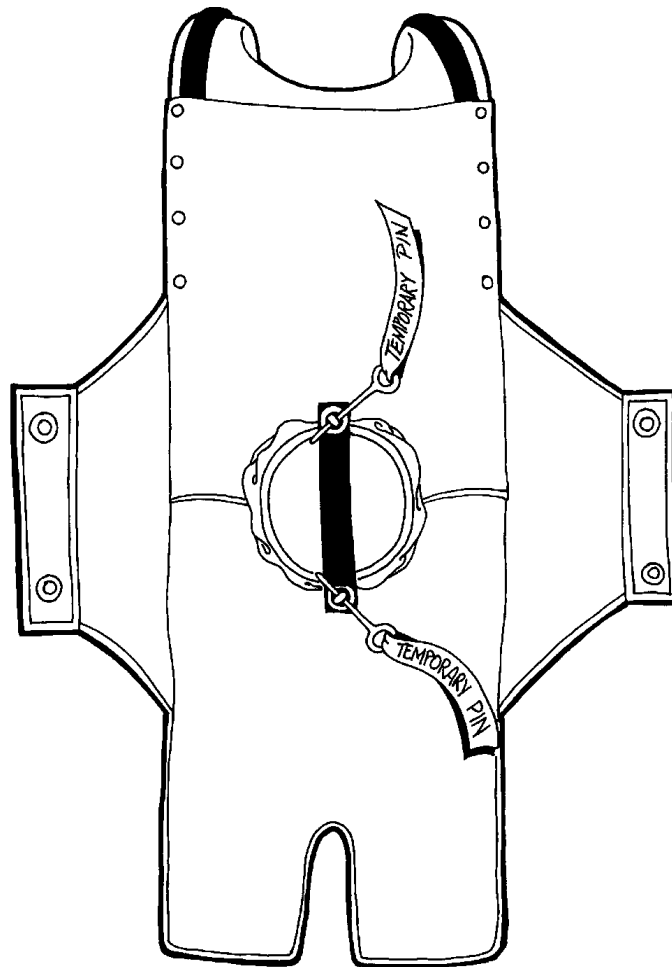

NOTE: After 7th January 1988 a Skyhook, Part Number B021-A became available with the grommets set into the pilot chute top. The B021-A may be used as an alternative to the B021 and strap in all models.

- Next, close the side flaps over the pilot chute. Pass the pull-up cords through the left, then right side flap and insert the two temporary pins to hold the flap closed.
- Insert the ripcord pins beside the temporary pins, starting with the bottom one first.
- Remove the temporary pins and pull-up cords.
- Seal the bottom ripcord pin with red tie thread (4.75 lbs max. breaking strain) and a lead seal.
- Enter packing details in the Packing Card log for the parachute.
- Account for all pull-up cords and temporary pins!

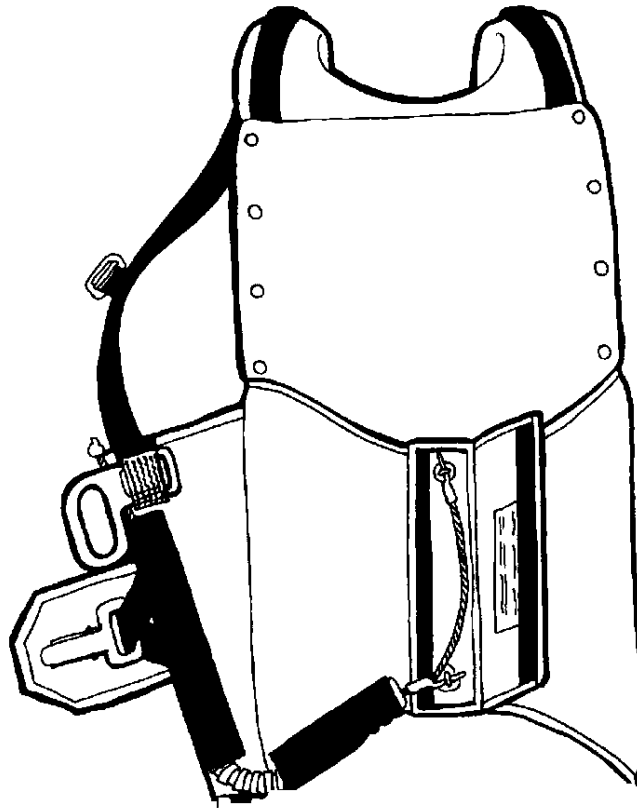

Replacement packing cards are available from Parachutes Australia by ordering part number A029.

12.0 CONTINUING PRODUCT SUPPORT

Parachutes Australia will maintain product support for the service life of the parachute.

Spare parts and materials shall be kept available to permit all types of repairs and modifications to be carried out on the parachute, both at the manufacturer's premises and at authorised maintenance establishments.

A Master Record Index (MRI) which fully defines the built standard of the parachute will be maintained by Parachutes Australia for the life of the parachute.

Parachutes Australia will notify maintenance organisations which subscribe to the Australian Parachute Federation Rigging Advisory Circular (RAC) service of every modification, change of approval, change of operational, maintenance or packing instruction which affects the Slimpack parachute.

13.0 REPLACEMENT PARTS AND MATERIALS

| ASSEMBLY COMPLETE SUB-ASSEMBLY PART MATERIAL | DESCRIPTION |
|--|--|
| T201 | T201 Slimpack Parachute assembly, standard category, civil use. Refer to section 2.0 Slimpack configurations. |
| T202 | T202 Slimpack Parachute assembly, low speed category, civil use. Refer to section 2.0 Slimpack configurations. |
| T204 | T102 Slimpack Parachute assembly, static line/ripcord deployed, civil use. Refer to section 2.0 Slimpack configurations. |
| S003-HS-1 | Slimpack Pack and Harness assembly, civil use, ripcord deployment only, standard category. Left hand inboard ripcord pull. |
| S003-G | Slimpack Pack and Harness assembly, civil use, static line/ripcord deployment, standard category. Left hand inboard ripcord pull. |
| P008A | Canopy, 26ft dia, Lopo conical, block constructed, standard category, orange and white alternating gores. |
| P015-1 | Canopy, Aerolite 22ft dia conical, zero porosity, block constructed, low speed category, multi-coloured, 'flat' diaper deployed. |
| B021 | Pilot chute, skyhook, 30 inch enclosed spring, 6 inch dia top, 4 inch diameter base, high drag. |
| B021 (S) | Strap, pilot chute B021 for use in Slimpack pack and harness assemblies (excluding model T204) |
| B021-A | Pilot chute, skyhook, especially manufactured for Slimpack model T204. May be used in all model Slimpacks and Thinbacks, incorporates shaped top with grommets included. |
| B019 | Bridle cord, 1 metre length, ½ inch tubular nylon. |
| A023 | Manual Slimpack Parachutes model T201, T202 and T204. |
| H006-M | Ripcord for earlier Slimpack S3 (SC) & S3 (LS). Refer to para 2.6 of this manual. |
| H006-1 | Ripcord for Slimpack model T201, T202 & T204 for S003-G & S003-HS-2 pack & harness assembly. |
| B069 | Closing loop, Slimpack model T201 & T202 |
| B074 | Static line, Thinback model S005-G/Slimpack model S003-G. |
| B077 | Closing loop(s), Slimpack model S003-G/Thinback model S005-G. |

| ASSEMBLY COMPLETE SUB-ASSEMBLY PART MATERIAL | DESCRIPTION |
|---|--|
| B045 | Toggles (pair), P015-1 Aerolite and P008A Lopo Canopy. |
| B029 (F)-1 | Diaper 'flat' Aerolite P015-1 canopy. |
| H008 | Snap, quick ejector, non-adjustable MS 22017, CAD plated. |
| H009 | Adapter, solid 3 bar, Parachute Harness shoulder adjustment, MS 22014-1. |
| H017 (21) | Housing, ripcord 21 inch length. |
| H036 | Snap, Parachute Harness, MS 22044. |
| H042 | Ring, V, adjustable, deep, Parachute Harness, MS 27765 (without spring tensioner). |
| H043 | Cap, metal coated, pilot chute base location, pack and harness. |
| H057 | Adjuster, chest strap, Parachute Harness. |
| H080 | Link, rapide, size no. 6, standard series 'N' ref 6.0 N, zinc plated steel, SWL 400kg. |
| M011 | Grommet and washer, parachute pack MS 20230, size no. '0', spur tooth, rolled rim, nickel plated brass. |
| M015 (C) | Fastener, cap, super easy lift, pack and harness closure, black oxide finish. |
| M015 (P) | Fastener, post, super easy lift, pack and harness closure, black oxide finish. |
| M015 (SO) | Fastener, socket, super easy lift, pack and harness closure, black oxide finish. |
| M015 (ST) | Fastener, stud, super easy lift, pack and harness closure, black oxide finish. |
| M105 (L) | Spring, pilot chute, 30 inch length, 6 inch top, 4 inch base. |
| M121 (A) | Plate, stiffener, for pilot chute compression between pack base and closing flap. |
| M128 | Grommet and washer, MS 20230, size 1, long shank, pack and harness inside back stiffener plate, loop location. |
| M129 | Grommet and washer size 1, spur tooth, rolled rim, nickel plated. |

| ASSEMBLY COMPLETE SUB-ASSEMBLY PART MATERIAL | DESCRIPTION |
|---|--|
| M001 | Cloth, nylon duck, pack construction, 400 denier, ³ / ₄ oz urethane coating. |
| M009 (R) | Webbing, buffer strips, pack and harness, to MIL-W-27265, type 12, colour black. |
| M014 (25HK) | Tape, velcro, hook, 25mm wide. |
| M014 (25P) | Tape, velcro, pile, 25mm wide. |
| M014 (50HK) | Tape, velcro, hook, 50mm wide. |
| M014 (50P) | Tape, velcro, pile, 50mm wide. |
| M018 (D) | Line, rigging, aerolite canopy. |
| M021 | Net, terylene, canopy, modification. |
| M022 | Webbing, harness construction, to MIL-W-27265, type 7, colour black. |
| M031 | Webbing, elastic, ripcord, pocket construction, 1½" width to MIL-W-5664, class 3, colour black, cotton & rubber. |
| M035 | Tape, pack binding, to MIL-T-5038, type 3, width ³ / ₄ inch. |
| M036 | Tape, ribbon weave, 1 inch, canopy lower band hem reinforcement, to MIL-T-5038, type 3. |
| M037 | Tape, ribbon weave, ½ inch, canopy longitudinal seam reinforcement, to MIL-T-5038, type 3, class 1. |
| M038-1 | Tape, square weave, 1 inch, pack & harness reinforcement to MIL-T5038, type 4, class 1 or 2. |
| M039 | Tape, herringbone weave, 9/16 inch wide, for canopy line attachment loop, to MIL-T5038 type 5. |
| M042 | Webbing, tubular nylon, ½ inch wide, to MIL-W-5625H, 1000lbs min strength, for bridle cord construction. |
| M043 | Webbing, tubular nylon, 1 inch, gold, to MIL-W-5625H, 4000lbs min strength, for canopy apex vent hem reinforcement, 26' Lopo canopy. |

| ASSEMBLY COMPLETE SUB-ASSEMBLY PART MATERIAL | DESCRIPTION |
|---|--|
| M047 | Thread, sewing, 5 cord nylon, unbonded, to MIL-V295D, size no. 5 cord, type 1, class 1, for harness construction. |
| M047-1 | Thread, sewing, 5 cord nylon, unbonded, to MIL-V295D, size no. 5 cord, type 2, class 1, for harness construction. |
| M049 | Line, braided nylon, canopy, rigging, 550 lb min strength to MIL-C-7515, type 2 or commercial equivalent. |
| M051-(colour) | Fabric, ripstop nylon, pilot chute top, 0-3 CFM 1.1oz, type F111 or equivalent. |
| M054-white | Fabric, ripstop nylon, canopy construction, 1.1oz to MIL-C-7020G, type 1 calendered to 30-50 CFM, 47 inch wide, white. |
| M054-orange | Fabric, ripstop nylon, canopy construction, 1.1oz to MIL-C-7020G, type 1 calendered to 30-50 CFM, 47 inch wide, orange. |
| M068 (N) | Sheet, nylon, 1.5mm thick, colour natural, pack & harness back inside stiffener. |
| M074 | Tape, kevlar, aerolite upper & lower lateral bands. |
| M076 | Webbing, nylon, 2 inch wide to MIL-W-4088 type 24, for grommet reinforcement, pack construction. |
| M081 | Mesh, internal reinforcing, pack assembly, firm finish, colour natural. |
| M087 | Elastic, cotton, 1 inch, webbing end stowage, to MIL-W5664, 70% cotton, 30% rubber, colour black. |
| M092 | Thread, sewing, nylon bonded for canopy, pack & pilot chute construction, to MIL-V-295D, size no. 'E' thread or commercial equivalent. |
| M101 | Foam, plastic, pack & harness comfort pad, ½ inch thick. |
| M171 | Label, TSO C23b details. |
| M023 | Webbing, buffer webbing, harness construction, to MIL-W-27265, type 8, colour black. |
| M138 | Nitrile rubber 'O' ring for Aerolite P015-1 diaper locking stows. |
| M126 | Cordura cloth, parachute pack construction. |

14.0 MODIFICATION (RECALL) ORDERS

- 14.1** Slimpack pack and harness assemblies identified as S3 (LS) and S3 (SC) use H006 ripcord which is recognisable by its orange 'plastic' handle.

The Slimpack S003-HS-2 and S003-G as from 1 July 1998 supercede these earlier models and use the H006-1 ripcord handle which uses a 'metal' ripcord handle.

Australian Parachute Federation (APF) Rigging Advisory Circular, RAC No. 506 recommends all ripcords used on emergency parachutes using 'plastic' handles should be replaced with 'metal' handles.

This recommendation was taken up by Parachutes Australia with the issue of MODIFICATION ORDER No. S003-MOD-01 as follows:

STATUS: MANDATORY

IDENTIFICATION: SLIMPACK MODEL S3 (LS) & S3 (SC)

EFFECTIVE DATE: INCORPORATED BY 1 JULY 1989

PROCEDURE: REMOVE RIPCORD PART NO. H006 WITH A PLASTIC RIPCORD HANDLE AND INSTALL A RIPCORD PART NO. H006 WITH A METAL RIPCORD HANDLE.
(AVAILABLE FROM THE MANUFACTURER FOR A CHANGE OVER PRICE OF \$15 INCLUDING RETURN POSTAGE).

15.0 RECORD OF REPAIRS AND ALTERATIONS

SLIMPACK SERIAL NUMBER: _____

DATE OF MANUFACTURE: _____

CANOPY TYPE: _____

SERIAL NUMBER: _____

DATE OF MANUFACTURE: _____

| DATE | WORK CARRIED OUT | RIGGER'S NAME | LICENCE NO. |
|------|------------------|---------------|-------------|
| | | | |